

Quality is more than a word

ESPEC

Walk-In Temperature (& Humidity) Chamber

E Series / High-Power Series



3 YEAR WARRANTY

 **LOW GWP**
REFRIGERANT

CE

Walk-In Chambers— Reborn to meet demand on a global scale

Walk-In Temperature (& Humidity) Chambers are used for testing construction materials and electronics fields as well as used in a wide range of research and development related to people and the environment.

They require high performance that can satisfy strict reliability tests for vehicles and other applications.

The High-Power Series was developed as a test chamber capable of withstanding even more demanding environmental tests.

It covers specialized automobile industry international standards for the latest technologies, including an expanded temperature control range, support for rapid temperature changes and high heat-generating loads, standards prescribed for Europe, and advance evaluations during the product development and design phase.



E Series

Achieving both energy savings and high accuracy

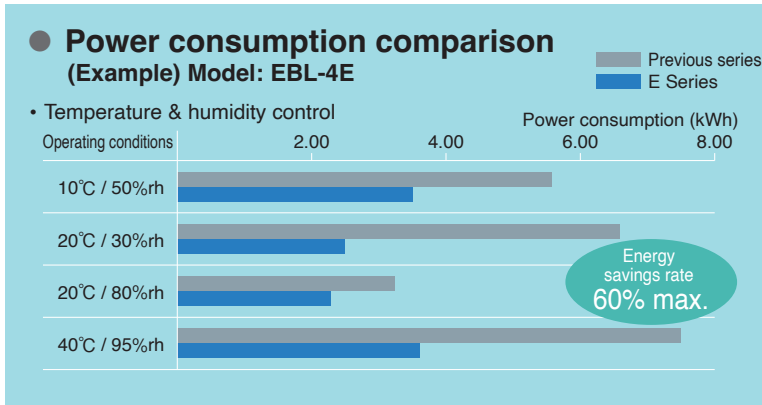

● **High-precision cooling system that induce energy-saving (Japanese patent No. 5427211)**

ESPEC has developed unique control systems including a wide-range refrigeration control system composed of a DC inverter and an electronic expansion valve that minimizes the required refrigerator power, and an active map system that can control and operate multiple refrigerators with minimum power consumption. Compared to previous models, this achieves energy savings of up to 60% together with high-precision refrigeration capacity.



● **Reduced power supply requirement!**

The cross-output control limits the maximum current of the heater and the humidifier, thereby reducing the required power supply capacity.



● **On-site assembling**

A chamber is assembled and installed on-site from panels, air conditioning unit and relating components.

● **The low floor structure for easy handling heavy items**

Easy to move in and out for large or heavy samples via double swing door and loading ramp.

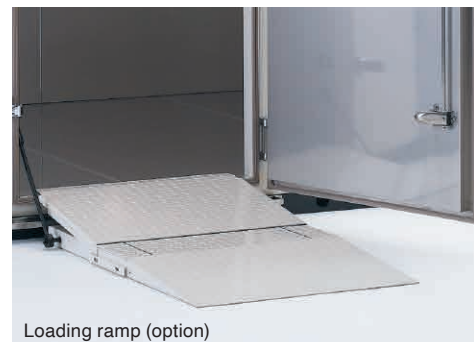

Low GWP Refrigerant



R-449A is available on request.

Model	Temperature & humidity chambers			Temperature chambers			
	EBE	EBL	EBR	EBF	EBU	EBUU	
System	Balanced Temperature and Humidity Control system (BTHC system) Vapor pressure divide control system			Balanced Temperature Control system (BTC system)			
Refrigeration system	Single-stage refrigeration system, air-cooled condenser or water-cooled condenser						
Allowable ambient conditions	5 to 40°C / 75%rh						
Performance*1	Temp. range*2	-40 to +80°C (-40 to +176°F)	-30 to +80°C (-22 to +176°F)	-10 to +80°C (+14 to +176°F)	-40 to +80°C (-40 to +176°F)	-30 to +80°C (-22 to +176°F)	-10 to +80°C (+14 to +176°F)
	Humid. range*2	10 to 95%rh (at +10 to +80°C)		20 to 95%rh (at +20 to +80°C)	—		
	Temp. / Humid. fluctuation*3	±0.5°C / ±4%rh			±0.5°C		
	Temp. variation in space*3	2.5°C					
	Temperature rate of change (Pull down)*3	0.4°C/min					
	Temperature rate of change (Heat up)*3	1°C/min					
Main unit (Panel assembly)	Exterior material	Color coated steel					
	Interior material	Stainless steel					
	Floor load capacity	Equal load distribution: 6 kPa (600 kgf/m ²)					
	Door	Single door W850 x H1800 mm					
	Insulation material	Urethane foam					
Air conditioner	Air circulator, heater, humidifier, refrigerator, evaporator, temperature sensor, humidity sensor			Air circulator, heater, refrigerator, evaporator, temperature sensor			
Refrigerant	R-404A [Low GWP Refrigerant R-449A]						
Fittings	Viewing window (W180 x H289 mm), Cable port (inner diameter 50 mm), Room lamp (LED), Ventilation, Ethernet port (LAN port), USB memory port, External output terminals						
Utility requirements	Power supply	200V AC 3 φ 50/60 Hz					
		220V AC 3 φ 50 Hz					
		380V AC 3 φ 50/60 Hz					
		400V AC 3 φ 50/60 Hz					

*1: Figures are for when ambient temperature is +5 to +32°C, cooling water temperature is +25 to +32°C, and there is no load and no specimen.

*2: The performance values are performances at the temperature sensor and humidity sensor (installed on the blow out of the air conditioner).

*3: The performance values are based on to IEC 60068-3-6:2001 (EBE, EBL, EBR), IEC 60068-3-5:2001 (EBF, EBU, EBUU).

Temperature and humidity control range (E Series)

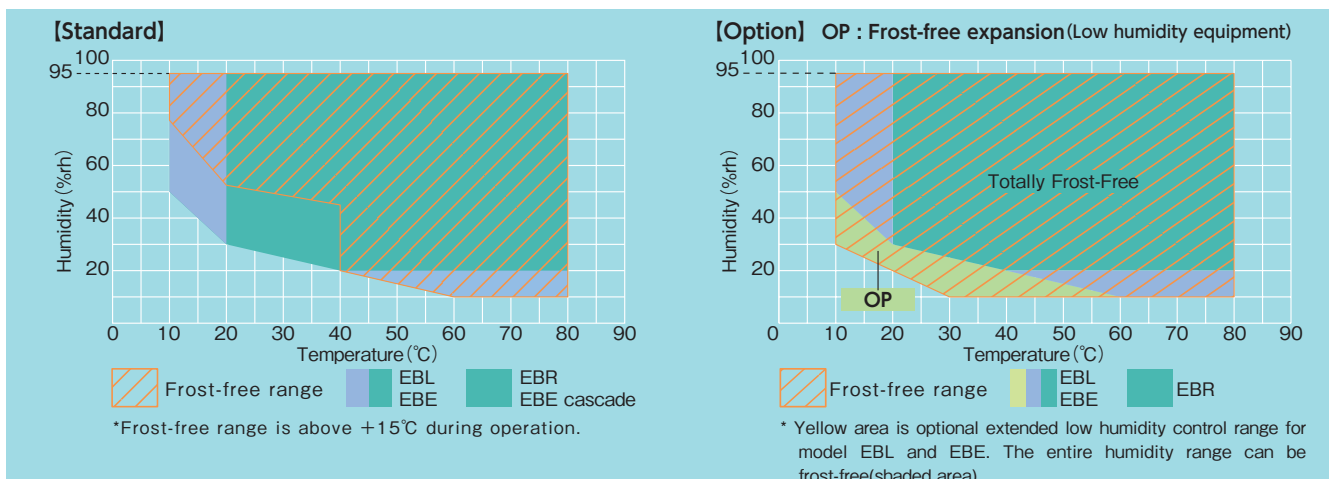

Outline size

Test chamber (Inside dimensions)

unit : mm

Type 1

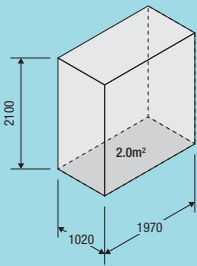

Type 2

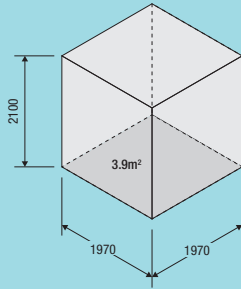

Type 3

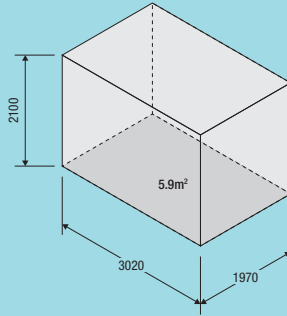

Type 4

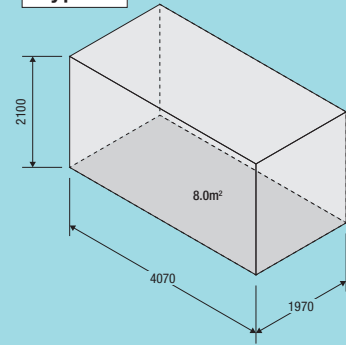

Type 6

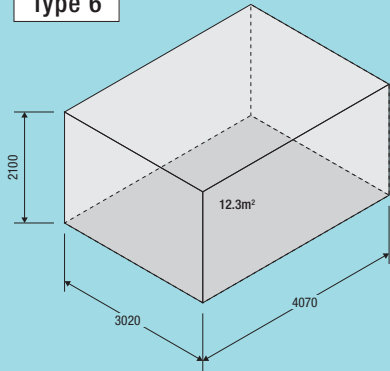

Type 8

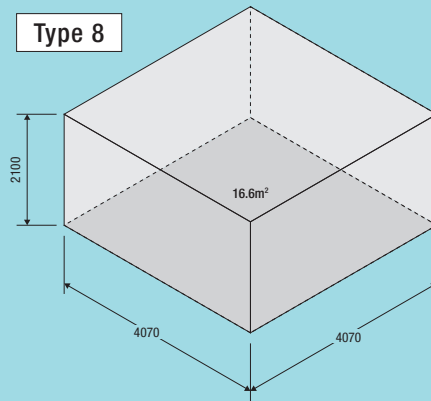

Type 10

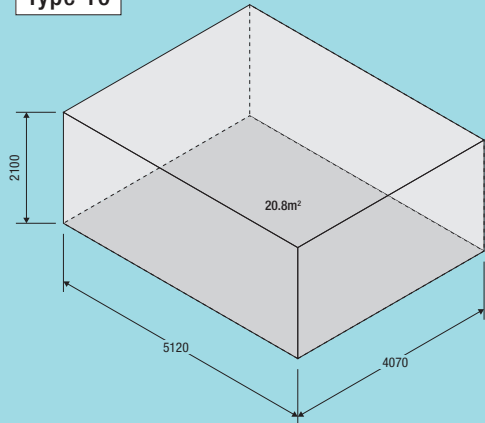

Type 12

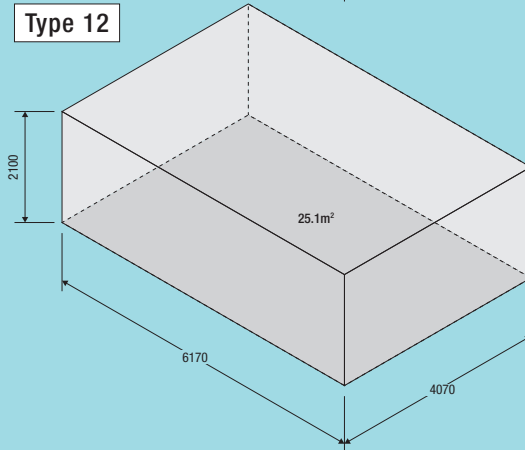

Air conditioner (Outside dimensions)

unit : mm

ACU10

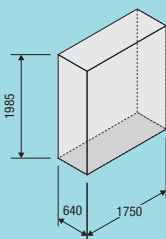

ACU20

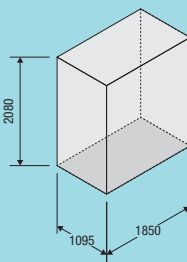

ACU30

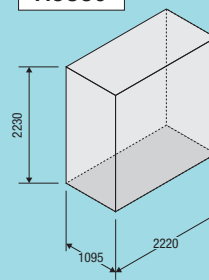

Installation Simulation Tool (AR [Augmented Reality])

Read the QR code with a smartphone or tablet camera to start the web browser.*1

View the intended installation location (a floor) through the camera to check the installation image in the web browser.*2



*This AR is an image.

Combination example of test chamber external view with door open and air conditioner *3 *4

<p>Type 1+ ACU10</p> 	<p>Type 2+ ACU10</p> 
 <p>Type 3+ACU10</p>	 <p>Type 4+ACU10</p>
<p>Type 6+ ACU20</p> 	<p>Type 8+ ACU20</p> 
 <p>Type 10+ACU30</p>	 <p>Type 12+ACU30</p>

*1 This service is designed specifically for use on smartphones. It will also work on some tablets. Operation has been confirmed in the Safari and Google Chrome browsers. Use the camera function of your smartphone or tablet to read the 2D codes.

Recommended environment

- OS: iOS 14 or higher, Android 9.0 or higher
- Browser: Safari (latest version), Google Chrome (latest version)
- Even if you meet the above conditions, this service may not operate normally on your terminal.
- Not all Android terminals support AR. For details on terminals that support AR, access the following URL.
<https://developers.google.com/ar/devices?hl=en>



Check available devices

*2 Precautions

- These contents can be used free of charge, but you will be charged communication fees to access them.
- Possible causes for the contents not being displayed properly include the camera capturing a location with no flat surfaces, objects being present on the flat surfaces, and insufficient brightness in the location.
- This service may not operate properly due to the communication environment.
- Before using AR to capture images, thoroughly check the surrounding area to make sure it is safe.

*3 Initially, models are displayed with roughly their actual sizes. Stretch and pinch to change the dimensions of displayed models.

Use this service only as a reference. It does not provide any guarantees for actual installation of chambers.

*4 The product image displayed in AR is temperature and humidity type.

For temperature type (EBUU, EBU, EBF), the controller displays and sensor sections are different from the image.

The combination of the test chamber and the air conditioner unit is an example, and the air conditioner unit changes depending on the performance.

High-Power Series

Support for high stress test with large capacity of chamber maximum 170 m³!

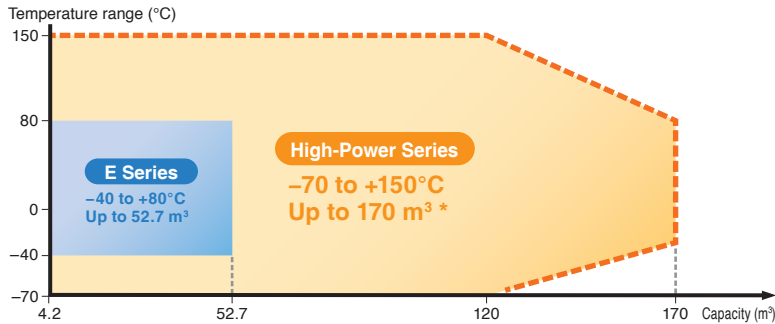

Comparison of temperature transition times (Type 12, 52.7 m³)

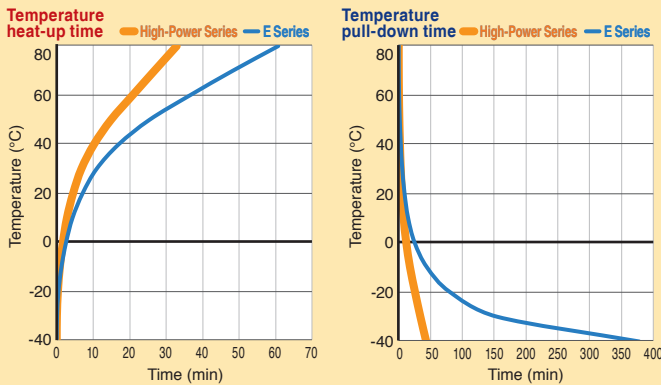

Conforming test standards

Temperature		Temperature and Humidity	
IEC 60068-2-14Nb	ISO 16750-4 (5.3)	IEC 60068-2-30	ISO 16750-4 5.6.1
	LV 124 L-03		ISO 16750-4 5.6.3
LV 124 K-01			LV 124 K-08
LV 124 K-02		IEC 60068-2-38	ISO 16750-4 5.6.2
LV 124 K-04			LV 124 K-09
ISO 16750-4 5.2		PV 1200	
		PV 2005	
		PR 308.2	
		IEC 60068-2-78	
		ISO 16750-4 5.7	
		LV 124 K-14	
		TP 303.5 a, b, c, d	

Possible to control from ultra-low temperature -70 to +150°C

Tests can be performed to simulate everything from super-cold environments to high-temperature environments such as mid-summer car interiors and bonnet.

* Temperature control with 170 m³ is -30 to +80°C. Please contact to your sales for details of specification.

Reducing time by rapid transition time

Even though chamber has large space 170 m³, chamber controls temperature, humidity but also rapid temperature transition.

Temperature rate of change 3°C/min (E series: 0.4°C/min)

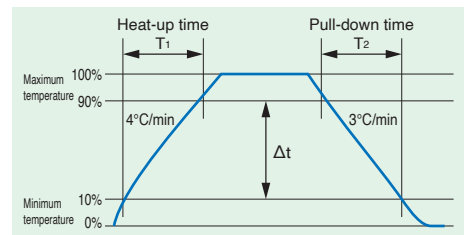

Conforms to IEC 60068-3-5:2001

$$\text{Temperature heat-up rate} = \frac{\Delta t}{T_1}$$

$$\text{Temperature pull-down rate} = \frac{\Delta t}{T_2}$$

Expressed as the rate of change (between 10% and 90%) per minute of the atmosphere at the center of the chamber.

Allowable heat load 13 kW at -40°C

It is possible to test during the electronic device or high heat-generating specimens such as automobile motors in low-temperature environments. The wide lineup of air conditioners allows for greater heat-generating loads in various applications.

Conforms to global automobile test standards

These products conform to the ISO 16750 international standard that is widely used for global procurement of vehicle devices and components, and also to the LV 124 standard created by European automobile manufacturers.

High-Power Series

-70 to +150°C / 20 to 95%rh

Model	Temperature & humidity chambers		Temperature chambers	
	EBE		EBF	
System	Balanced Temperature and Humidity Control system (BTHC system) Vapor pressure divide control system		Balanced Temperature Control system (BTC system)	
Refrigeration system	Water-cooled cascade refrigeration system			
Allowable ambient conditions	5 to 40°C / 75%rh			
Performance*1	Temp. range*2	-70 to +150°C		
	Humid. range*2	20 to 95%rh (at +20 to +80°C)	—	
	Temp. / Humid. fluctuation*3	±0.5°C / ±4%rh	±0.5°C	
	Temp. variation in space*3	-70 to -41°C, +81 to 150°C: 5.5°C -40 to +80°C: 2.5°C		
	Temperature rate of change (Pull down)*3	3°C/min		
	Temperature rate of change (Heat up)*3	4°C/min		
Main unit (Panel assembly)	Exterior material	Color coated steel		
	Interior material	Stainless steel		
	Floor load capacity	Equal load distribution: 6 kPa (600 kgf/m ²)		
	Door	Single door W850 x H1800 mm		
	Insulation material	Urethane foam		
Air conditioner	Air circulator, heater, humidifier, refrigerator, evaporator, temperature sensor, humidity sensor	Air circulator, heater, refrigerator, evaporator, temperature sensor		
Refrigerant	7.5 kW cascade R-449A + R-23, 15 kW cascade R-449A + R-508A			
Fittings	Viewing window (W180 x H289 mm), Cable port (inner diameter 50 mm), Room lamp (LED), Ventilation, Ethernet port (LAN port), USB memory port, External output terminals			
Utility requirements	Power supply	200V AC 3 φ 50/60 Hz		
		220V AC 3 φ 50 Hz		
		380V AC 3 φ 50/60 Hz		
		400V AC 3 φ 50/60 Hz		

*1: Figures are for when ambient temperature is +5 to +32°C, cooling water temperature is +25 to +32°C, and there is no load and no specimen.

*2: The performance values are performances at the temperature sensor and humidity sensor (installed on the blow out of the air conditioner).

*3: The performance values are based on to IEC 60068-3-6:2001 (EBE), IEC 60068-3-5:2001 (EBF).

To minimize our chambers potential environmental impact

R-449A is the best alternative to R-404A



*R-449A is available on request

10.4-inch large-screen touch panel that allows intuitive operation

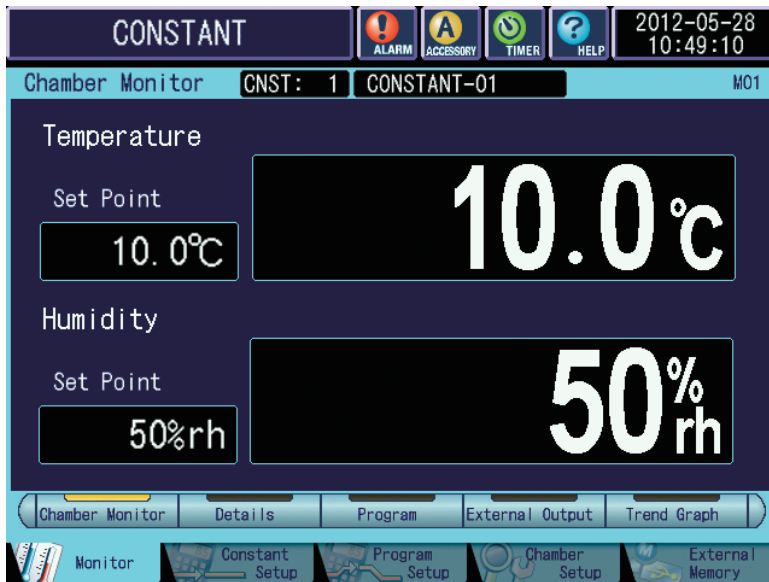

- **A variety of program settings**

40 profiles (up to 99 steps per profile) can be registered for programmed operation, and 3 profiles for constant operation.

- **Output of trend-graph data**

The setting and measured data are shown in a graph. The data can be recorded in internal memory or recorded directly to USB memory, and backups can also be created. The scale for temperature, humidity, and time in the display can be zoomed in and out.

- **Reminder function**

The display shows chamber status, such as during defrosting or automatic humidifying water replacement is in progress. The INFO icon notifies the user of the timing for humidifier or CFC inspection. The necessary times and items can be set, improving the convenience of chamber management.

- **Function for recovery after a power failure**

The user can select either “turn OFF power” or “continue operation” when recovery occurs after a power failure.

- **Multi-language display**

The display language can be easily changed from Japanese to English, Chinese (simplified or traditional), or Korean. Select the appropriate language for use.

- **Test profile edit and copy**

It is possible to edit the test profiles registered in the chamber using a PC web browser. They can also be copied to a different chamber using USB memory.

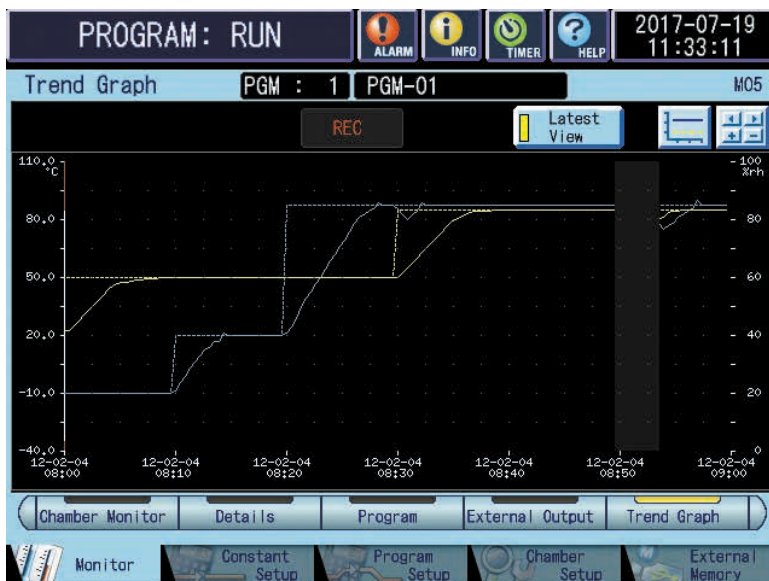

- **Test profile copy and PC edit**

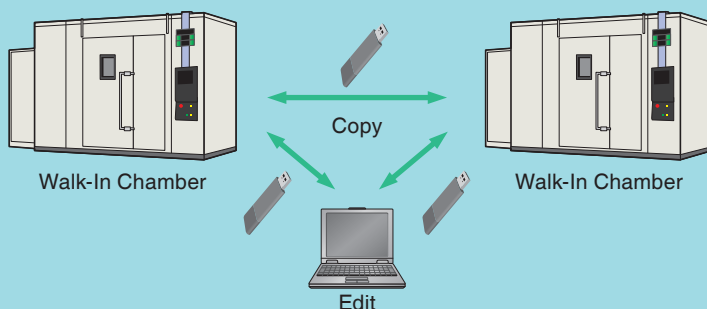

USB memory port

Remote monitoring improves test management efficiency and allows trouble to be identified and corrected at an early stage.

● Editing of test profiles (Option: Remote control function)

It is possible to use a PC web browser to edit the test profiles registered in the chamber, start and stop operation, and perform other communication with the chamber.

● Recording temperature and humidity settings and measurements

By saving data (at an approximately 30 second cycle) in internal memory and accessing it from a PC, it is possible to display a graph showing up to 100 days of data in the browser. It is also possible to download the data to the PC in CSV format (comma delimiter).

● Download test profiles

Via the Pattern Manager Lite software installed on your PC, edit programs according to your testing needs.

The Pattern Manager Lite

It is a PC software can be downloaded from the Test Navi website.

● E-mail alert

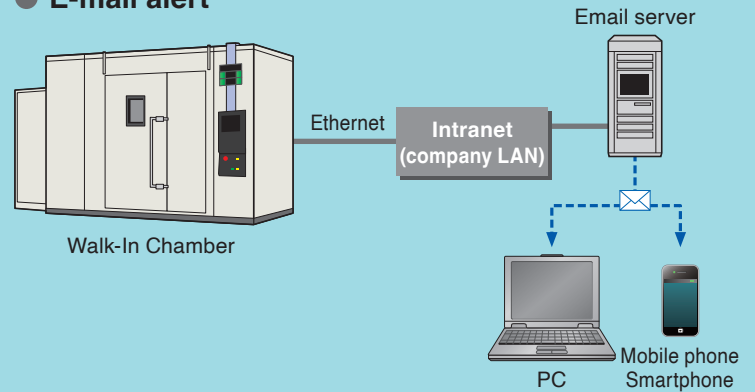

When an alarm is triggered, an email is sent to the registered PC or mobile address.

* Connection to a mail server is required to use e-mail alert.

● Test Navi (<https://www.test-navi.com/eng/index.html>)

This website provides practical knowledge on environmental testing that ESPEC has acquired through years of experience, as well as covering everything from the fundamentals to the latest information on environmental and reliability testing.



- Updates for chamber controller software
- Download test profiles from a list of environmental test standards

ESPEC OnlineCore (Sold separately)

Central control system recommended for multiple environmental test chambers installations

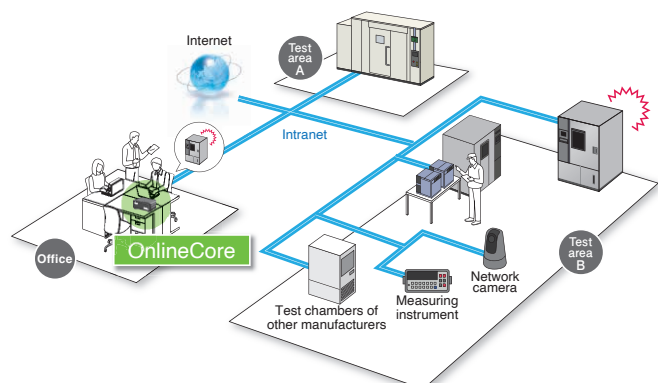

Required Equipment (Outdoor condenser Unit)

● Water-cooled type

- It has been prepared water-cooling equipment or when the air-cooling equipment in the installation location is not sufficient

● Remote air cooling

- It is difficult to prepare water-cooling equipment

* Depending on the ambient condition, it is possible to recommend indoor air-cooled condensing unit.

Safety Features (for Both E Series and High-Power Series)

- | | | | |
|--|--|--|--|
| <ul style="list-style-type: none">• Control circuit overcurrent protection• Cartridge fuse for control circuit short-circuit protection• Fan motor short circuit protection• Electrical compartment door switch• Specimen power supply control terminal• System error (error/warning)• Room temp. compensation disconnection detection circuit• Dry-bulb temp. disconnection detection circuit• Wet-bulb temp. disconnection detection circuit (temperature and humidity type) | <ul style="list-style-type: none">• Absolute upper/lower temp. limit alarm (built-in temp./humidity controller)• Reverse-prevention relay• Fan motor overcurrent protection• Overheat protector• Heater short-circuit protection• Heater overcurrent protection• Refrigerator temp. sensor Disconnection detection circuit• Refrigerator circuit temp. outside range• Refrigerator high/low-pressure pressure switch• Refrigerator short-circuit protection | <ul style="list-style-type: none">• Refrigerator overcurrent protection• Humidifier short-circuit protection (temperature and humidity type)• Humidifier overcurrent protection (temperature and humidity type)• Humidifier dry heat protector (temperature and humidity type)• Humidifier thermal fuse (temperature and humidity type)• Humidifier water level detection (temperature and humidity type) | <ul style="list-style-type: none">• Temp. upper deviation limit alarm (built-in temp./humidity controller)• Absolute upper/lower humidity limit alarm (built-in temp./humidity controller) (temperature and humidity type)• Water suspension relay (except for air-cooled types) |
|--|--|--|--|

Options

Some options cannot be installed due to the control temperature (humidity) range. Contact sales for more information.

Low-GWP refrigerant R-449A

Because R-449A has a lower Global Warming Potential (GWP), its use can contribute to reducing global warming gas emissions.

Changes the refrigerator unit refrigerant to R-449A.

Paperless recorder

A temperature & humidity recorder that utilizes a liquid-crystal display fitted with a touch-panel.

Display: 5.7 inch color touch panel
Scan interval: 5 sec. (default)

Internal recording media:

Flash memory 8 MB

External recording media:

CF memory card

(Supplies with a 256 MB CF card)

USB flash drive

< Temperature type >

No. of input channel: Temperature 1
(5 more channels can be turned ON)

< Temperature & humidity type >

No. of input channel: Temperature 1,
Humidity 1
(4 more channels can be turned ON)



Temperature (humidity) recorder

<Temperature type>

• -50 to +100°C 100 mm 6-dot system

<Temperature and humidity type>

• -50 to +100°C / 0 to 100%rh
100 mm 6-dot system

Recorder output terminal

This terminal outputs the temperature and relative humidity in the test area.

Time signal terminal

Adds 8 standard relay contacts (time signal).

Remote control function

Allows test conditions to be changed and operation to be started or stopped at a chamber which is connected via LAN.
(See P.10.)

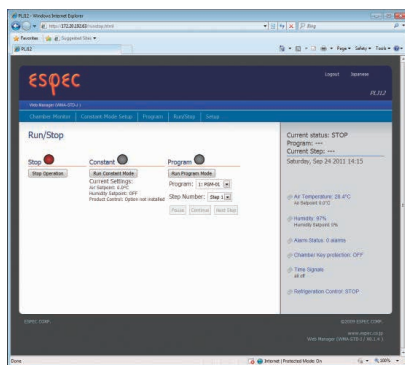

Run/stop operation

Interface

- RS-485
- RS-232C
- GPIB

Communication cable

- RS-485 5 m / 10 m / 30 m
- GPIB 2 m / 4 m

Additional cable port

With standard specifications, a 50 mm diameter port is provided.

- 25 mm
- 50 mm
- 100 mm
- 150 mm
- 200 mm

Enlarged viewing window

Changes from a W180 x H289 mm to a W295 x H425 mm large viewing window. The window uses heat-resistant glass that includes a heating element to prevent fogging.



Large viewing window Standard viewing window

Chamber wall viewing window

Installed on chamber wall viewing windows (reinforced heat-resistant glass with heating element) for observing the inside of the temperature (humidity) chamber are available.

- Small (W350 x H250 mm)
- Large (W600 x H400 mm)

Hands-in port (with viewing window W350 x H250 mm)

It is used for manipulating the specimen in the chamber from outside the chamber.
(Inner diameter 150 mm x 2 holes)

Interior plug socket

This socket supplies power inside the chamber. Different types of sockets are available according to the temperature and humidity in the specifications.



Safety precautions

- Do not use specimens which are explosive or inflammable, or which contain such substances. Doing so is dangerous and may lead to fire or explosion.
- Do not place corrosive substances inside the chamber. If a corrosive substance is produced by the specimen, the lifetime of the unit may be significantly shortened, in particular due to corrosion of stainless steel, resin, and silicone materials.
- Do not place life forms or substances that exceed allowable heat generation.
- Be sure to read the operation manual before operation.

Options

Some options cannot be installed due to the control temperature (humidity) range. Contact sales for more information.

Floor reinforcement

Distributes the concentrated load that occurs when specimens are carried into the chamber on a trolley, preventing distortions and dents in the floor. Additional frames to support the floor panels also enhance distributed load resistance.

Protective flooring (rubber type)

Prevents operators from slipping and prevents damage and dents.

Status indicator light

Indicates three chamber states: OPERATION, PERSONNEL INSIDE, and ALARM.



Operation indicator

Indicates "OPERATION" during operation.

Personnel indicator

Indicates "PERSONNEL INSIDE" when workers have entered the temperature (humidity) chamber.

Alarm indicator

Indicates "ALARM" in red when a chamber fault occurs.

Rotating pilot lamp

In case of malfunction, the lamp connected to the safety circuit is activated, thus attracting the operator's attention even from a distance.



Emergency stop pushbutton (turn-to-reset type)

A pushbutton is used to stop operation immediately in case of emergency.

* The breaker does not trip.

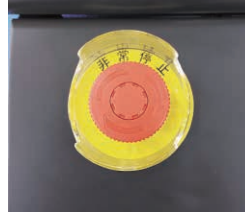

Operator safety mushroom

A mushroom-head button is installed to protect workers who enter the temperature (humidity) chamber. When pressed, chamber operation stops and the safety buzzer sounds an alarm.



Grounding terminal

The grounding terminal for use, such as measurement equipment to be brought into the chamber.



Electrical grounding in chamber

Short-circuits each insulation panels by the ground conductor, and connects them to the ground line inside the electrical compartment.

In-chamber work timer

The lamp and buzzer are activated to inform the person outside of chamber when time is passed set on timer.

Intercom

Allows to talk between personnel inside and outside the chamber.



Interior

Exterior

Cold-weather suit

Cold weather protective clothing including headwear, a pair of gloves, a pair of boots and a two-piece suit. (For use in chamber at -40°C)

Water leakage detector

Alarm for detecting water leakage from chamber or air conditioning unit by leakage sensor.

Independent temperature overcooling alarm

In case of malfunction due to overcooling, operation is terminated and an alarm message is displayed, preventing freezing and damage to specimens inside the chamber.

Humidity sensor (temperature & humidity chamber only)

This eliminates the need to replace the wick, and allows the dry-bulb humidity sensor to measure low humidity ranges that it otherwise would be unable to measure.

Options

Some options cannot be installed due to the control temperature (humidity) range. Contact sales for more information.

Thermocouple

Used to measure the temperature at a desired measurement point inside the temperature (humidity) chamber, or to measure the specimen temperature.

Full-ceiling air duct

Lowers and stabilizes the air circulation speed to protect the specimen.

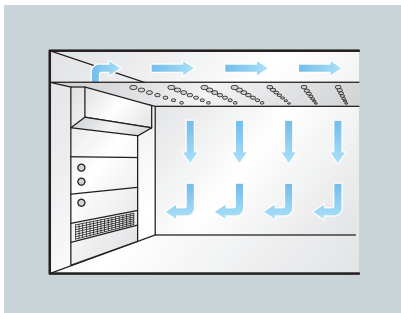

Loading ramp

This ramp is used to move heavy specimens into the chamber. The ramp is available in a removable type and a lever type.



Loading ramp (lever type)

Double swing door

The standard single door (W850 x H1800 mm) can be changed for a double swing door (W1400 x H1800 mm).



Additional door

Two types are available: single-swing and double-swing doors. Both come with a viewing window (W180 x H289 mm).

Entrance curtain

Minimizes atmospheric disturbance of temperature and humidity when opening and closing the door.

Preparation room

Minimizes atmospheric disturbance of temperature and humidity when opening and closing the door. Also used as a measurement room for specimens.

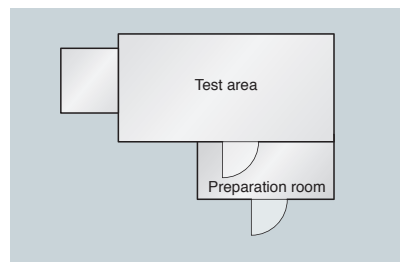

Frost-free expansion (Low humidity equipment) (for temperature & humidity chambers only)

This expands the temperature and humidity control range on the low temperature side, preventing the formation of frost and extending the continuous operation time. (See P.4.)

Airflow adjuster

The airflow adjuster inside the temperature (humidity) chamber can reduce the effects of wind on the specimen by adjustable in 4 steps air speed velocity.



Refrigerator for heat load

An additional refrigerator can be installed in order to permit heat generation from the specimen during operation tests.

Auxiliary humidifier (for temperature & humidity chambers only)

Effective for heat load generation and high humidity specification. Pure water is required.

Water purifier (for temperature & humidity chambers only)

Connects to the steam humidifier and optional auxiliary humidifiers. Improves the reliability of measurements over long periods of time and extends the life of the humidifiers.

- Ion-exchange water purifier



Ion-exchange water purifier

Flow switch (for water-cooled models only)

This safety switch for the refrigeration unit activates and shuts down the equipment when the cooling water level becomes too low or is cut off.

Exhaust air duct (indoor air-cooled specification)

This directs waste heat from the refrigerator to the ceiling of the test area, preventing heat from building up in the machine box.

* In chamber water leak detection system and dew tray to catch dripping water are also available to detect and prevent water damage.

Case Study

ESPEC products can be tailored to suit your application. For details, please contact sales. 3-year warranty is not available

Vehicles Vehicle environmental test area



Perform sunlight tests in the target temperature and humidity environment. The temperature from the sensors installed on the vehicle is sent as feedback for control of the light intensity, making it possible to maintain the vehicle at a constant heat load.

Temperature and humidity range	-40 to +80°C / 30 to 80%rh
Interior dimensions	W5000 x D8000 x H3000 mm
Sunlight chamber control temperature	+40 to +100°C

* The surface temperature of a black panel located 1,000 mm below the lamps can be raised up to +30°C from the test area temperature.

Construction materials Indoor/outdoor environmental test area



This can be used to test heat insulation and condensation of construction materials such as walls and windows. The test area is divided into Area A (indoor conditions) and Area B (outdoor conditions), thereby reproducing the indoor/outdoor environmental conditions of a building. Area B is equipped with a sunlight system and water spray system, and can also be used for weather resistance tests consisting of repeated sunlight and water spray. Area B is also moveable, allowing the construction material specimens between test areas A and B to be easily installed and removed.

Temperature and humidity range	-15 to +50°C / 30 to 95%rh (at +10 to +50°C)
Testable specimens	Max. 3,000 kg
Dimensions inside test area	W4500 x H4000 x D4100 mm
Floor load resistance	6 kPa {600 kgf/m ² } (equally distributed load) * Specimen load supported by concrete foundation

Persons Vehicles Construction materials Artificial weather chamber



The ESPEC artificial weather chamber is capable of reproducing all kinds of weather environment factors including temperature, humidity, barometric pressure, rain, fog, snow, sunlight, wind, and atmospheric composition either individually or in combinations. In addition to ordinary environments, it can reproduce burning deserts, extreme cold Antarctic conditions, high elevations, stratosphere, and other environments, producing the optimal weather environment for the research purpose and subject.

Temperature and humidity range	-40 to +80°C / 20 to 90%rh (at +20 to +60°C)
Dimensions inside test area	W6000 x H4500 x D9000 mm
Snowfall	30 mm/h
Rain	0.3 to 200 mm/h
Sunlight	400 W/m ² to 1200 W/m ² (metal halide lamps)
Air flow equipment	0 to 20 m/s

Case Study

3-year warranty is not available

Environment Factor Modules

Adding environment factor modules to an existing or new temperature chamber allows for Combined Sequential Environmental Test Systems.

Evaluate automotive sensors in a blizzard without being in a blizzard.

Environment factor modules



New temperature chamber



Weather Environment

Environment factor modules



Snow generator



Rain generator



Fog generator



Sunlight (LED)



Sunlight (infrared lamp)



Airstream fan

Weather Environment

Snow



Rain

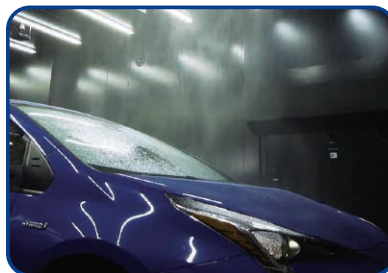

Fog



Sunlight



Wind

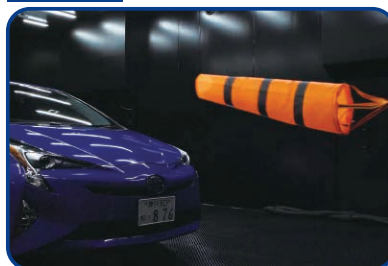

Sunlight

+

Fog

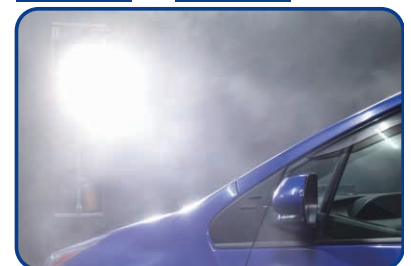

Case Study

ESPEC products can be tailored to suit your application. For details, please contact sales. 3-year warranty is not available

Secondary batteries 

Temperature chamber with safety mechanisms



With the expansion of hybrid vehicles and EV, there is growing need to connect charging/discharging systems to secondary battery modules for testing. This temperature chamber with safety mechanisms can be customized so that there is ample room for wiring work when a large EV secondary battery is installed in the chamber. During charging/discharging evaluations and various tests, there is the risk of gas leakage from the secondary battery resulting in fire. Therefore a number of safety mechanisms have been installed so that tests can be performed safely.

Temperature range	-40 to +80°C
Interior dimensions	W3020 x H2100 x D1970 mm (Contact sales for more information.)

Persons 

Low oxygen training chamber



This normal pressure, low oxygen chamber lowers the oxygen concentration while maintaining sea-level (normal) pressure. By supplying low oxygen air with a converted oxygen concentration, it is possible to reproduce a low oxygen environment similar to high elevations while remaining at sea level. In a high-elevation training gym, it is possible to monitor not only the concentration of oxygen and other gases, but also to monitor the exercise time and biometric information of the trainer and user. This product has been introduced at a large number of facilities centered on research institutions and universities.

Oxygen concentration	18.6 to 11.2% (Equivalent elevation: 1,000 to 5,000 m)
Temperature and humidity range	+22 to +26°C / 60 to 70%rh

Pharmaceuticals 

Stability Test Chamber



This system supports stability testing (acceleration test) ($\pm 1^\circ\text{C}/\pm 5\%\text{rh}$ at $40^\circ\text{C}/75\%\text{rh}$) of the notification of the Ministry of Health, Labour and Welfare. (Japanese patent no.6258110)

Temperature & humidity range	+25 to +40°C / 60 to 75%rh
Temperature and humidity maximum and minimum range	$\pm 1^\circ\text{C} / \pm 5\%\text{rh}$

Case Study

ESPEC products can be tailored to suit your application. For details, please contact sales. 3-year warranty is not available

5G/IoT 

Shield performance / Environmental test area with radio darkroom

● Radio darkroom (2 connected chambers)

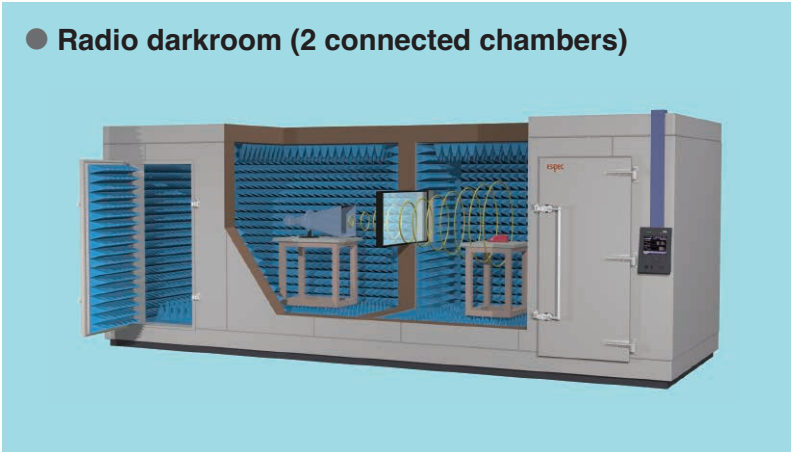

Shield performance	Frequency band 0.5 GHz to 30 GHz Attenuation rate 60 dB or more
Features	<ul style="list-style-type: none"> ● A radio wave absorber is installed in the interior. ● The 2 test areas can be controlled to different temperatures. ● Radio wave transmitting material is installed between the test areas.
Example of application	Base station with large transmission output (macrocell)

5G/IoT 

Constant Temperature RF Anechoic Chamber

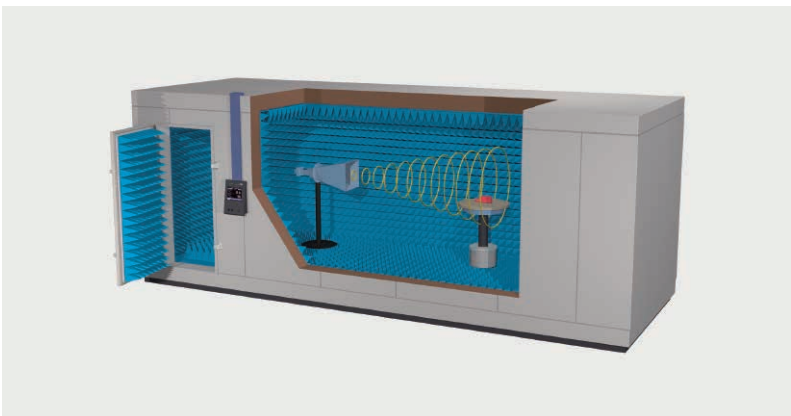

For 5G base stations, temperature dependency evaluations in OTA measurements are required because antennas and wireless send/receive modules have been integrated into a single unit to reduce transmission losses. These systems are capable of conducting temperature tests while possessing the functionality of an RF anechoic chamber with an attenuation rate of 60 dB or more at 30 GHz frequencies.

Temperature range	-40°C ~ +100°C	
Shielding performance	Frequency range	0.5GHz to 30GHz
	Attenuation rate	60 dB or higher

* Contact ESPEC for shielding performance and interior dimensions.

Online Exhibition 5G/IoT Solution Expo



https://www.espec.co.jp/english/products/5g_iot-webexpo/top/base.html

ESPEC CORP. <https://www.espec.co.jp/english>

Head Office

3-5-6, Tenjinbashi, Kita-ku, Osaka 530-8550, Japan
Tel: 81-6-6358-4741 Fax: 81-6-6358-5500

ESPEC NORTH AMERICA, INC.

Tel: 1-616-896-6100 Fax: 1-616-896-6150

ESPEC EUROPE GmbH

Tel: 49-211-361850-0

ESPEC ENVIRONMENTAL CHAMBERS

SALES AND ENGINEERING LTD. STI. (Turkey)

Tel: 90-212-438-1841 Fax: 90-212-438-1871

ESPEC ENVIRONMENTAL EQUIPMENT (SHANGHAI) CO., LTD.

Head Office

Tel: 86-21-51036677 Fax: 86-21-63372237

BEIJING Branch

Tel: 86-10-64627025 Fax: 86-10-64627036

GUANGZHOU Branch

Tel: 86-20-83317826 Fax: 86-20-83317825

SHENZHEN Branch

Tel: 86-755-83674422 Fax: 86-755-83674228

SUZHOU Branch

Tel: 86-512-68028890 Fax: 86-512-68028860

TIANJIN Branch

Tel: 86-22-26210366 Fax: 86-22-26282186

XI'AN Branch

Tel: 86-29-88312908 Fax: 86-29-88455957

CHENGDU Branch

Tel: 86-28-88457756 Fax: 86-28-88474456

WUXI Branch

Tel: 86-510-82735036 Fax: 86-510-82735039

ESPEC TEST TECHNOLOGY (SHANGHAI) CO., LTD.

Tel: 86-21-68798008 Fax: 86-21-68798088

ESPEC ENGINEERING (THAILAND) CO., LTD.

Tel: 66-3-810-9353 Fax: 66-3-810-9356

ESPEC ENGINEERING VIETNAM CO., LTD.

Tel: 84-24-22208811 Fax: 84-24-22208822

ISO 9001 (JIS Q 9001)

Quality Management System Assessed and Registered

ESPEC CORP. has been assessed by and registered in the Quality Management System based on the International Standard ISO 9001:2015 (JIS Q 9001:2015) through the JSA Solutions Co.,Ltd.

* The organization of these certificates is
ESPEC CORP. Japan.



ISO 27001 (JIS Q 27001)

Quality Management System Assessed and Registered

* The organization of these certificates is
ESPEC CORP. Japan.



ISO 14001 (JIS Q 14001)

Environmental Management System Assessed and Registered

* The organization of these certificates is
ESPEC Group Japan.

